

**1914 HF**  
Arched Spindle Bed with High Footboard

**1914T Twin**  
44"W x 81"D x 49 1/2"H

**1914F Full**  
60"W x 81"D x 50"H

**1914Q Queen**  
66"W x 84"D x 50"H

**1914K King**  
82"W x 84"D x 50"H

**Available Options:**

**CAL King**

**High or Low Footboard**

**Storage Drawers**

**Mattress Only or  
Mattress & Box Spring**

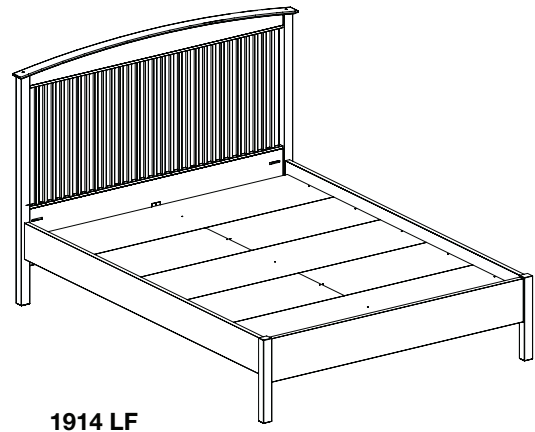

**1914 LF**  
Arched Spindle Bed with Low Footboard

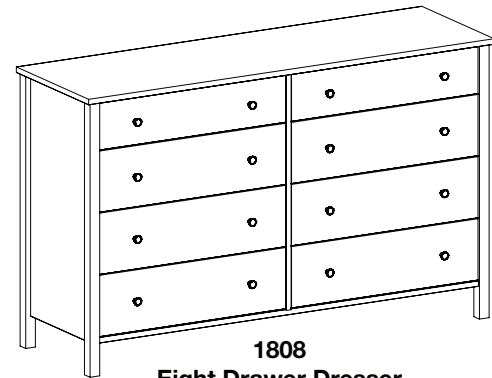

**1808**  
Eight Drawer Dresser  
63"W x 19 1/2"D x 39"H

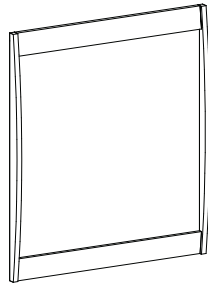

**1813**  
Mirror  
31"W x 36"H

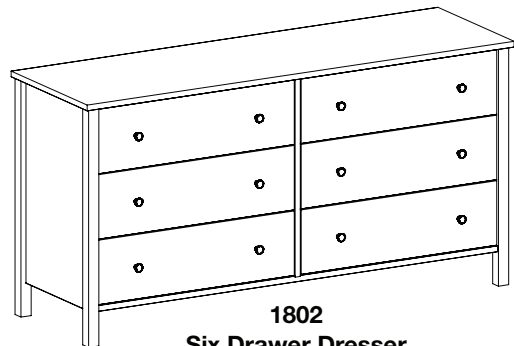

**1802**  
Six Drawer Dresser  
63"W x 19 1/2"D x 33"H

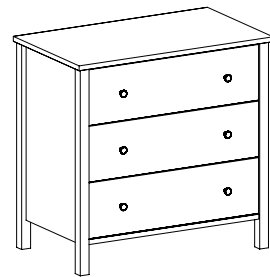

**1803-3**  
Three Drawer Chest  
33"W x 19 1/2"D x 33"H

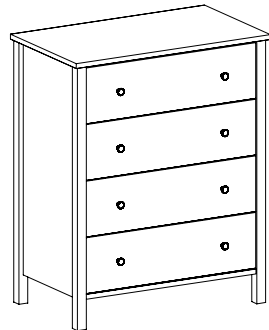

**1804-4**  
Four Drawer Chest  
33"W x 19 1/2"D x 39"H

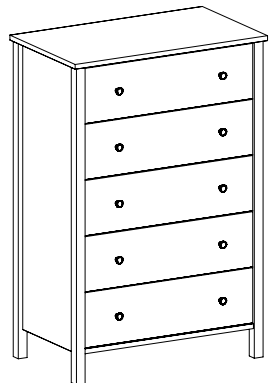

**1804**  
Five Drawer Chest  
33"W x 19 1/2"D x 50"H

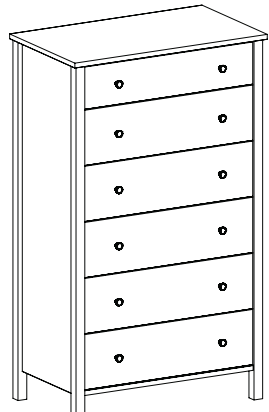

**1806**  
Six Drawer Chest  
33"W x 19 1/2"D x 57"H

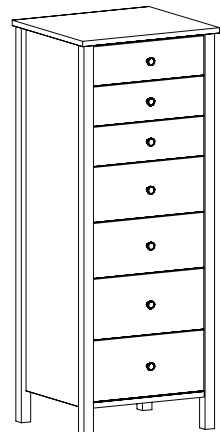

**1807**  
Seven Drawer Lingerie Chest  
22"W x 19 1/2"D x 57"H



**1811**  
Horizontal Wardrobe  
49"W x 20"D x 50"H

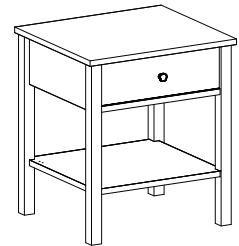

**1810**  
One Drawer Nightstand  
22"W x 19 1/2"D x 25"H

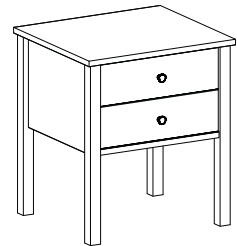

**1810-2**  
Two Drawer Nightstand  
22"W x 19 1/2"D x 25"H

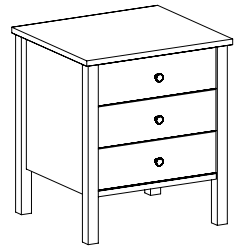

**1810-3**  
Three Drawer Nightstand  
22"W x 19 1/2"D x 25"H

Dimensions are nominal. Adjustable feet come standard on all case pieces.

Thor's Elegance • Brandon Vermont  
thorselegance.com • 802-247-3014

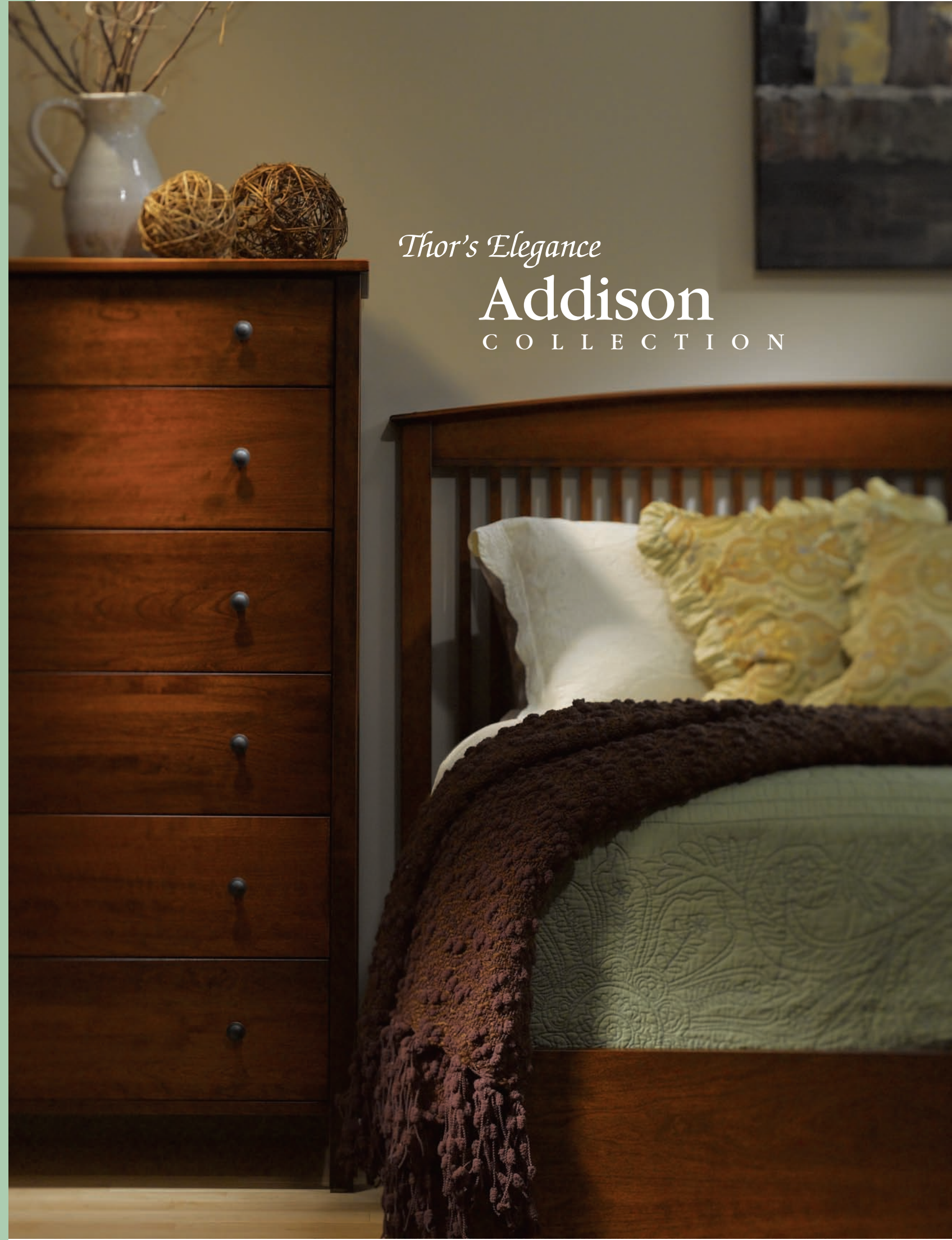

*Thor's Elegance*

**Addison**

COLLECTION



1914Q LF Arched Spindle Bed in American Black Cherry with Cinnamon Finish



1802 Six Drawer Dresser and 1813 Mirror in American Black Cherry with Cinnamon Finish

*Thor's Elegance*  
**Addison**  
 COLLECTION

The Addison Collection is a blend of fine Vermont craftsmanship influenced by the clean lines of Shaker styling. These pieces are admired for the minimalist design approach and functionality.



1810 One Drawer Nightstand in American Black Cherry with Cinnamon Finish



1806 Six Drawer Chest in American Black Cherry with Cinnamon Finish

- *Sustainably Harvested, Milled & Handcrafted Entirely in the USA*
- *Precision Finger Dovetailed Drawer Construction*
- *Superior 100 lb. Test Metal, Under Mounted Concealed Drawer Glides*
- *Backs Screwed on, NOT Stapled*
- *Selection of Durable Hand Wiped Finishes*
- *Variety of Stunning Knob & Handle Possibilities*

